

ED_-W

FAKRO®

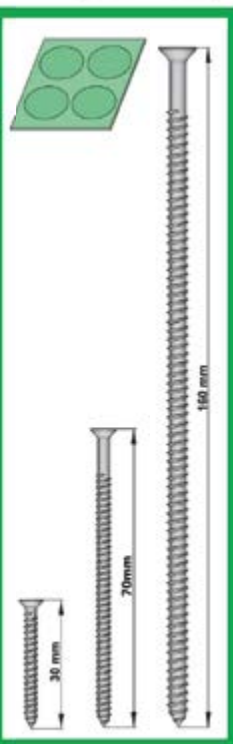

NC1BL IMEDW/OLM/216T

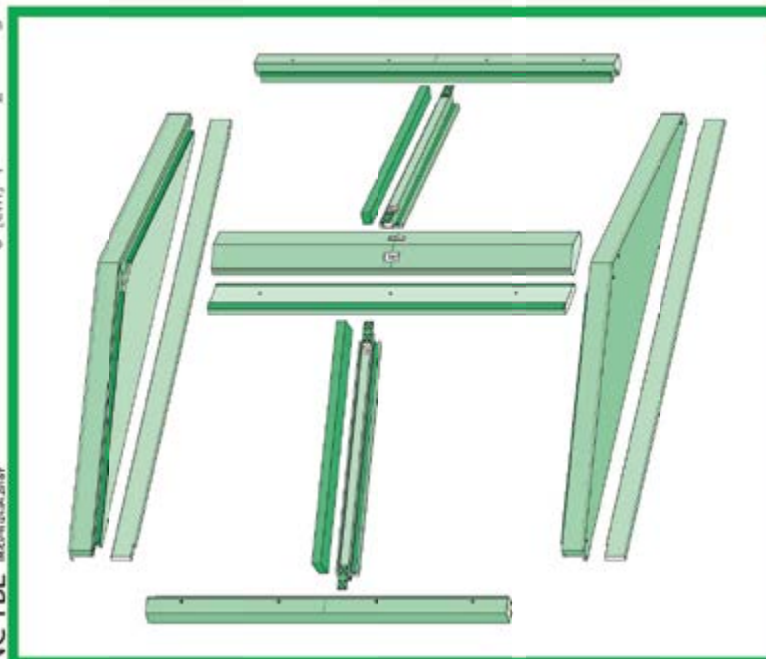
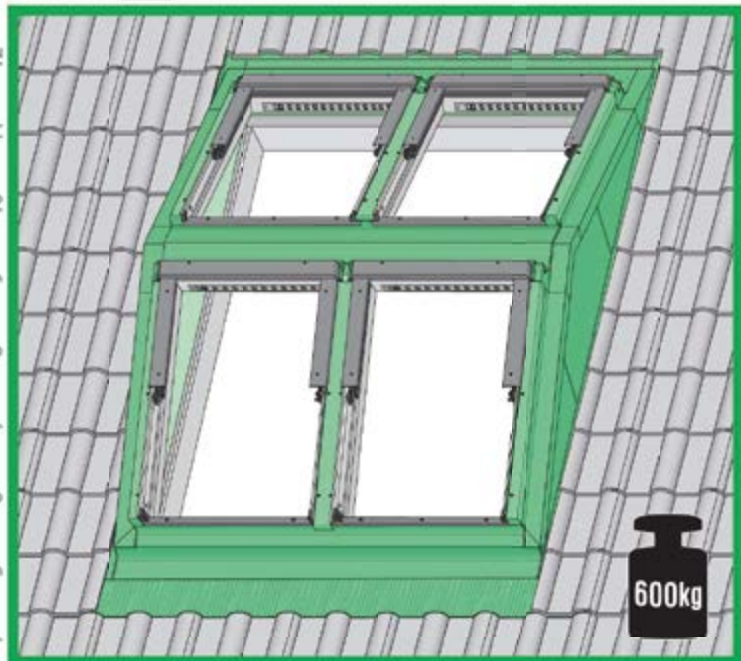
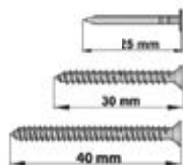

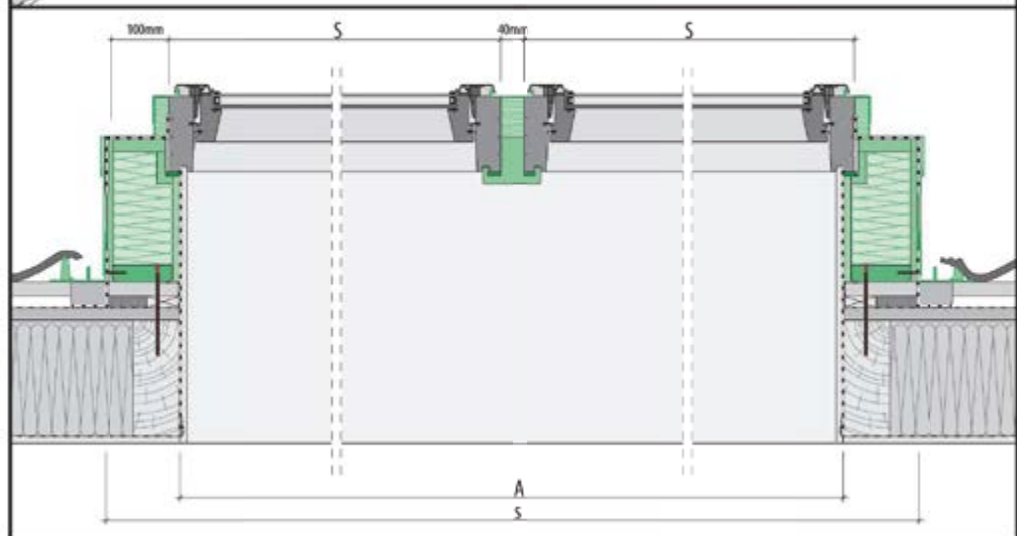
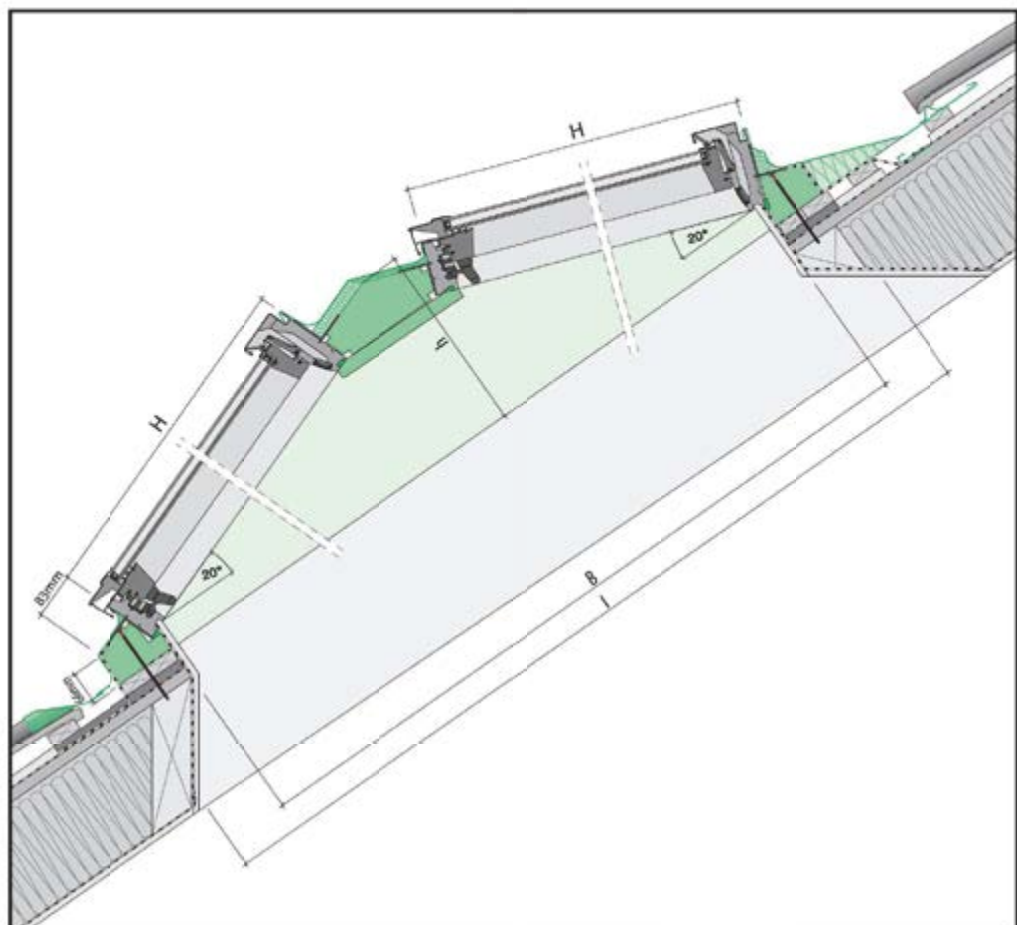

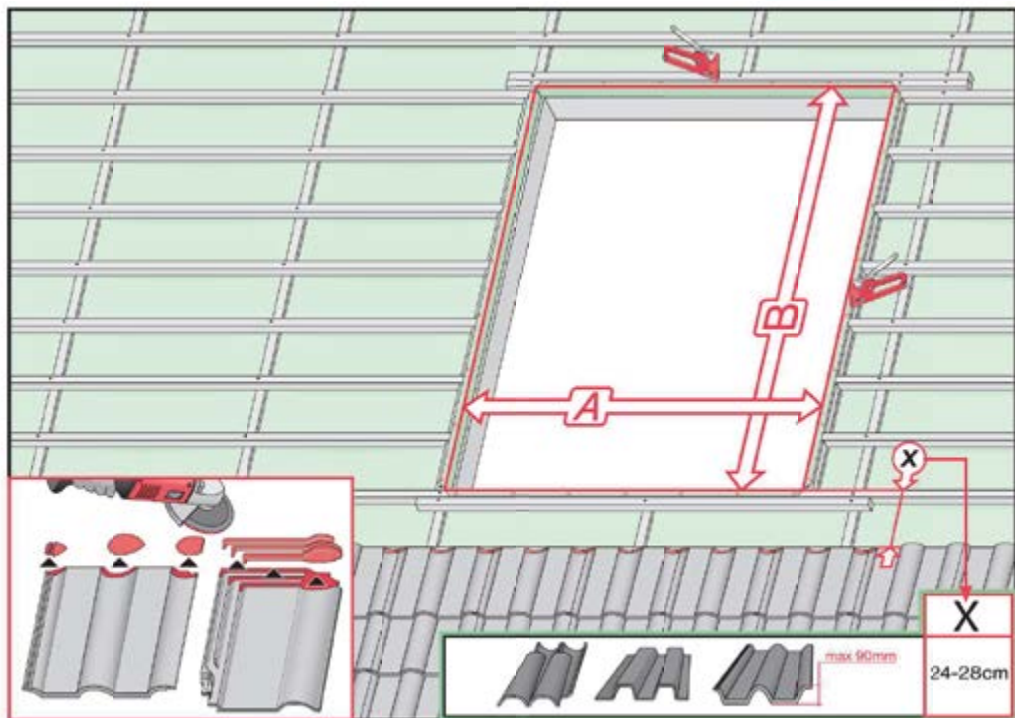
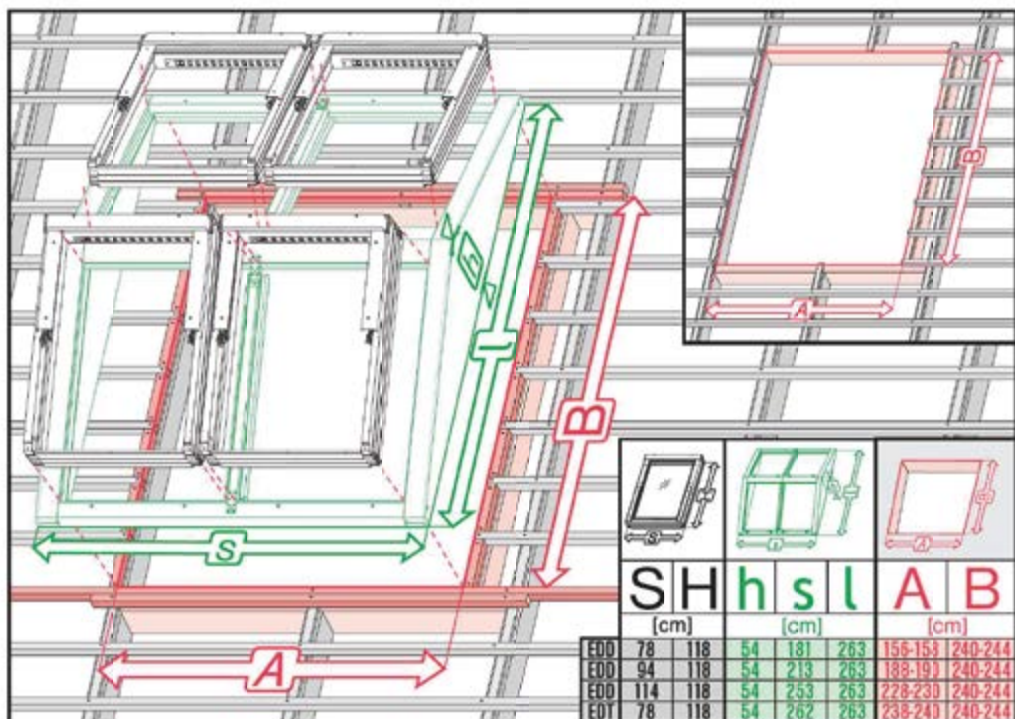

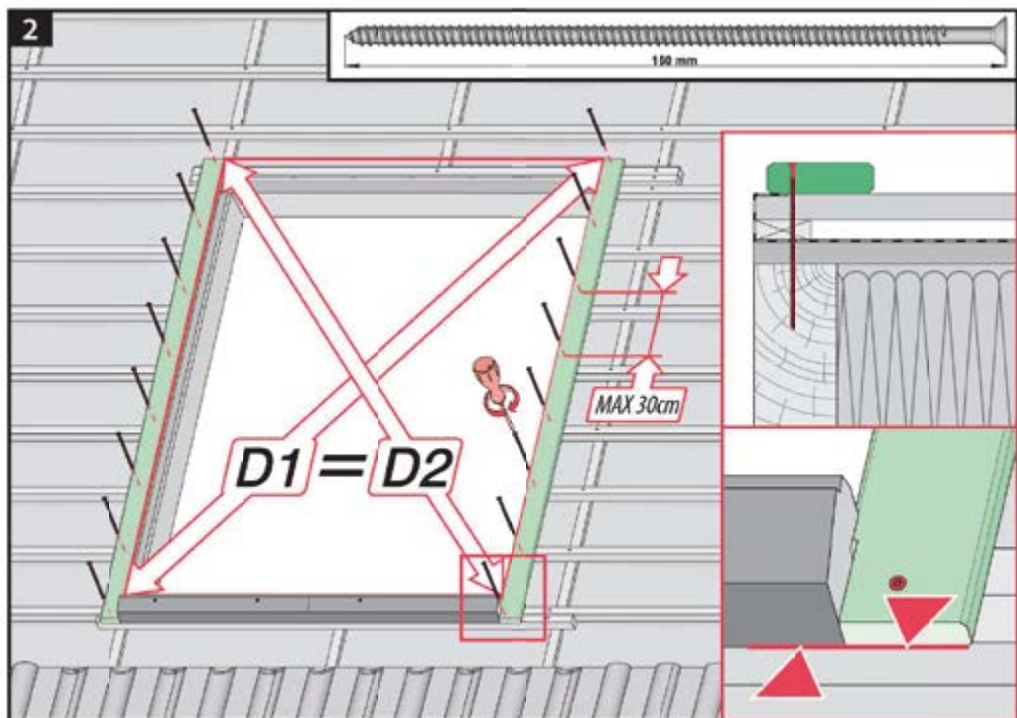
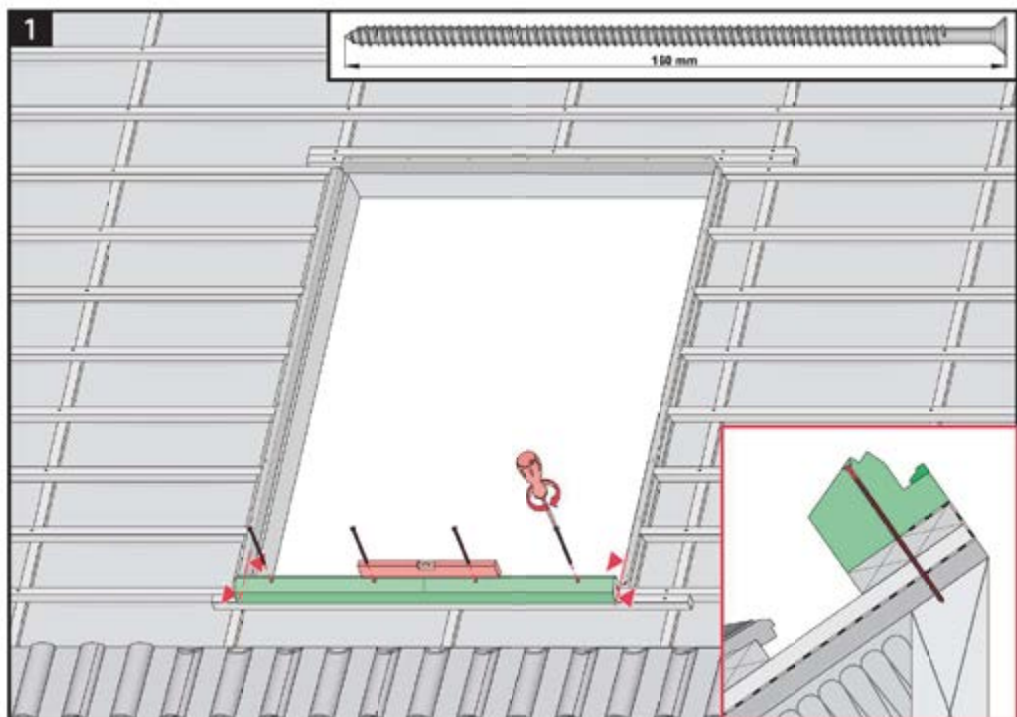

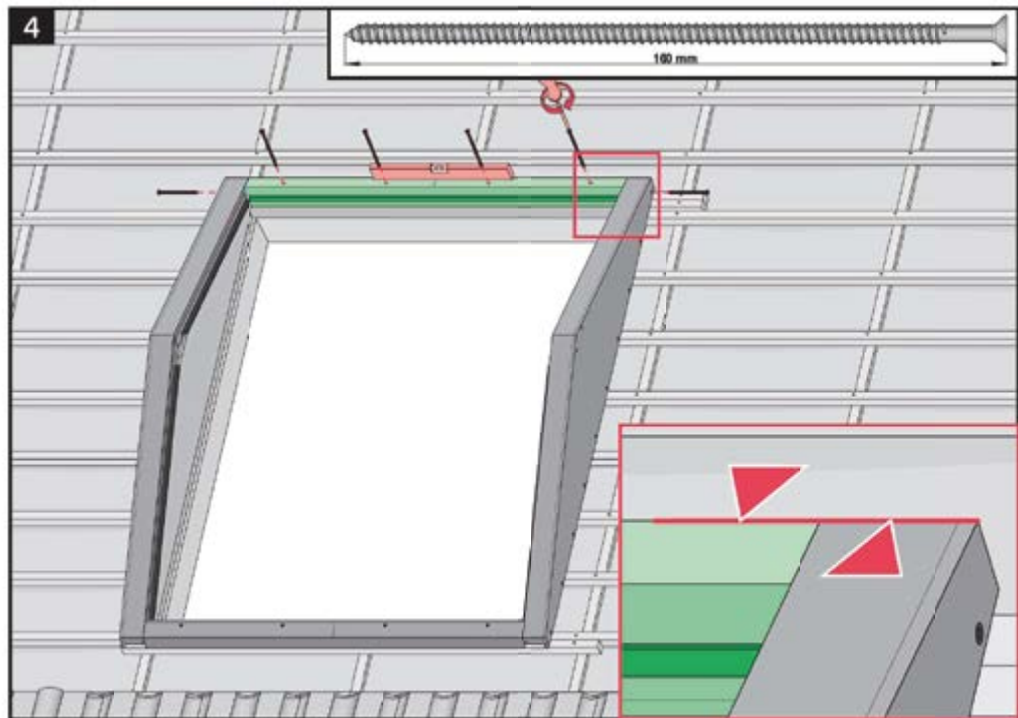
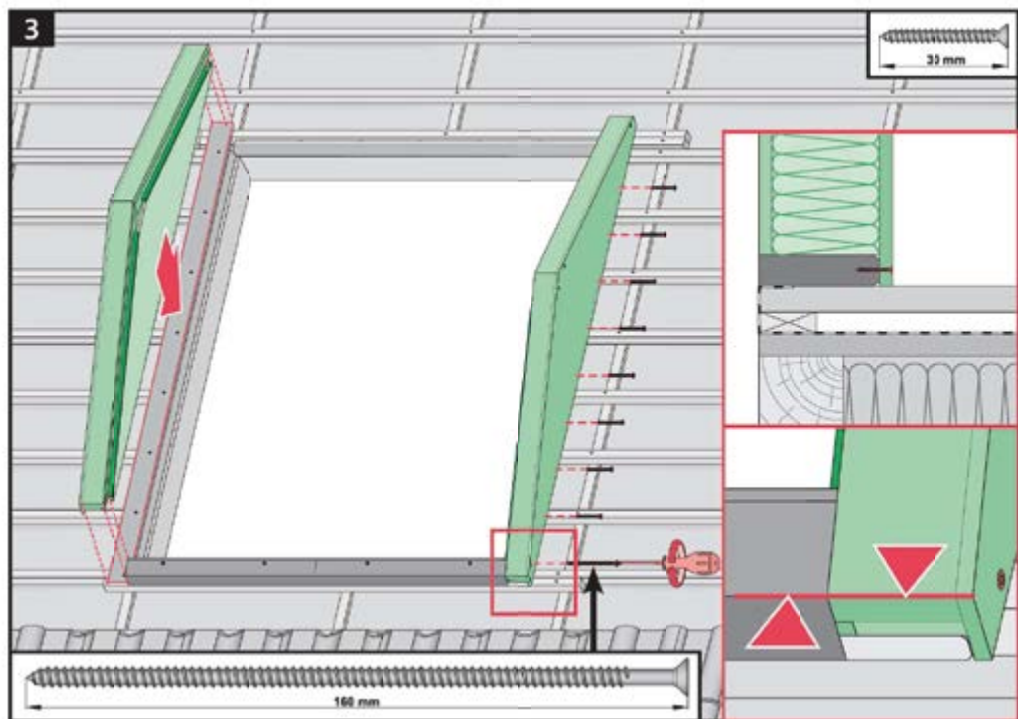

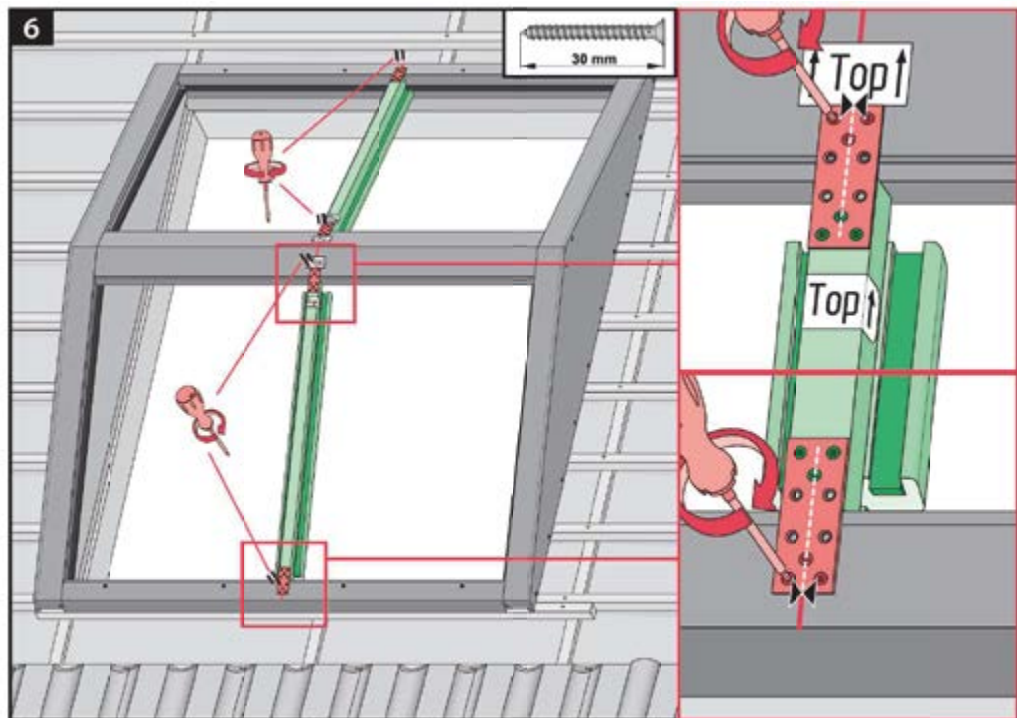
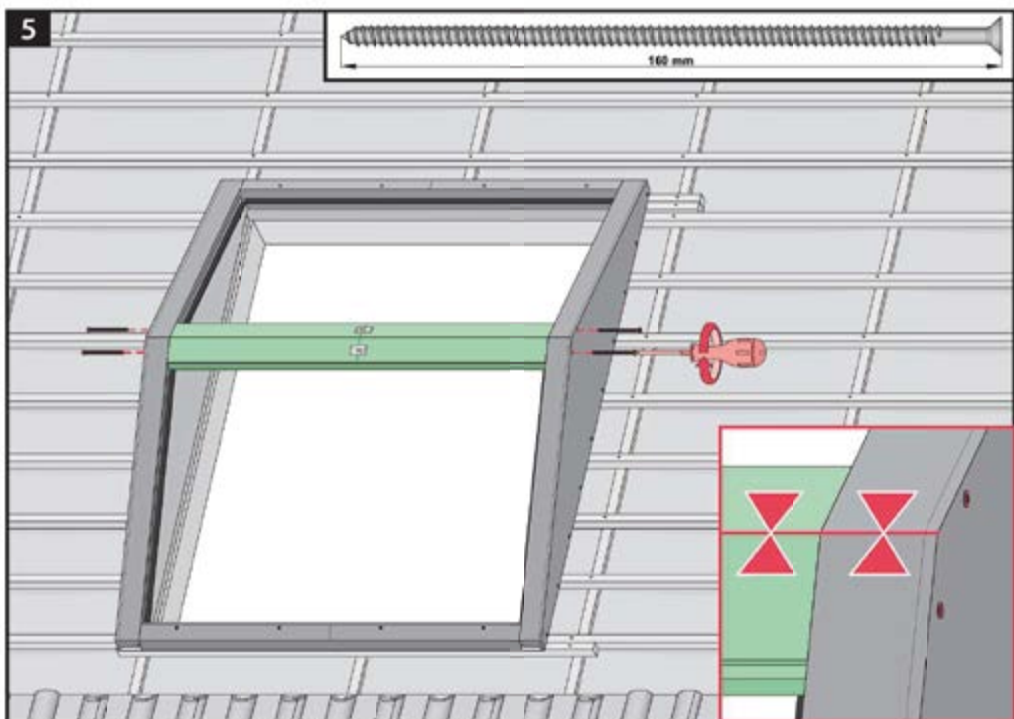

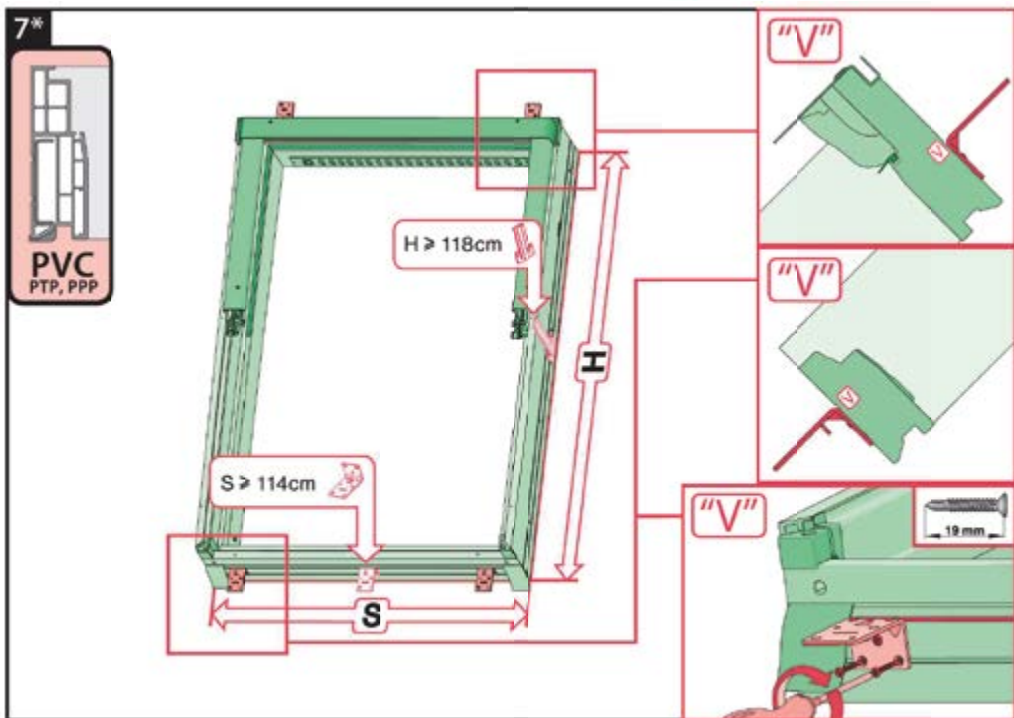
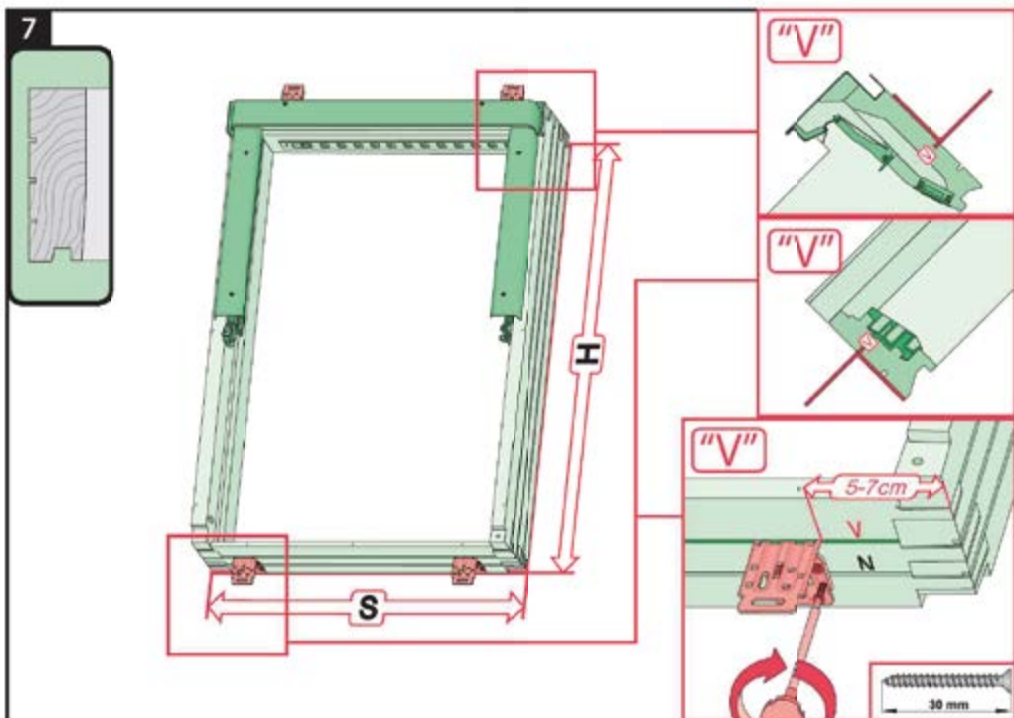

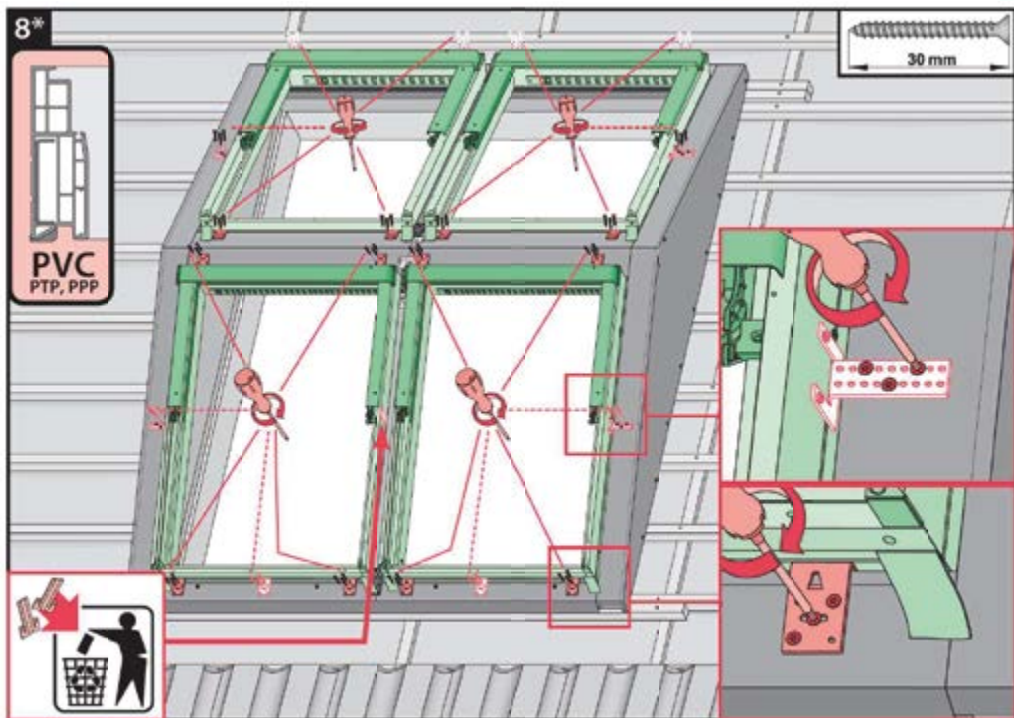
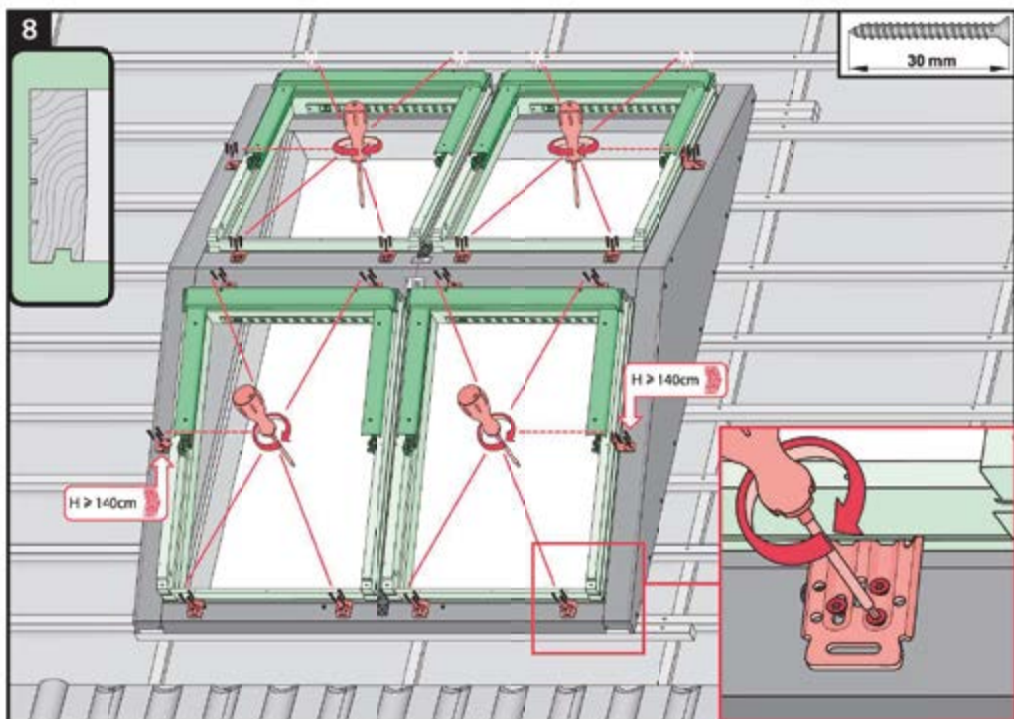

8* FTP-V ELECTRO

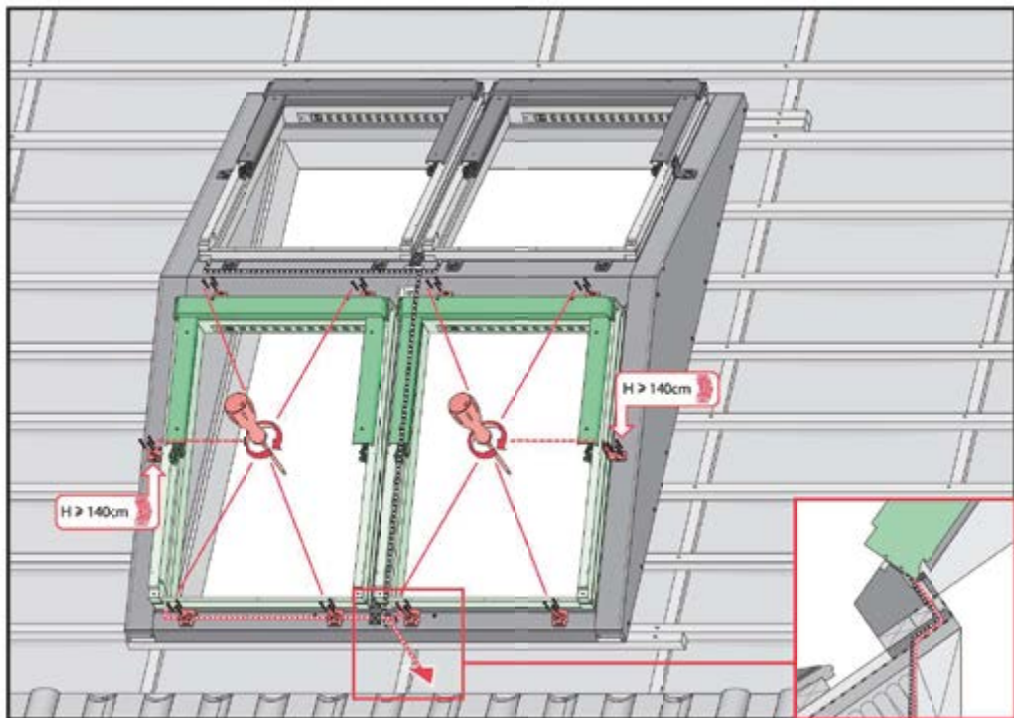
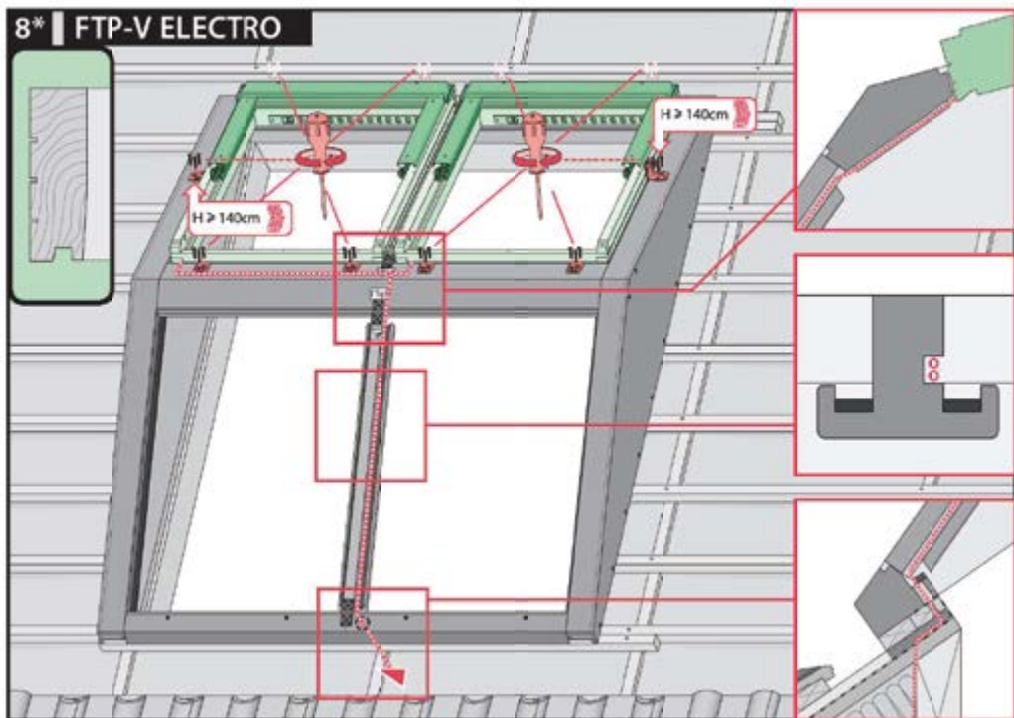

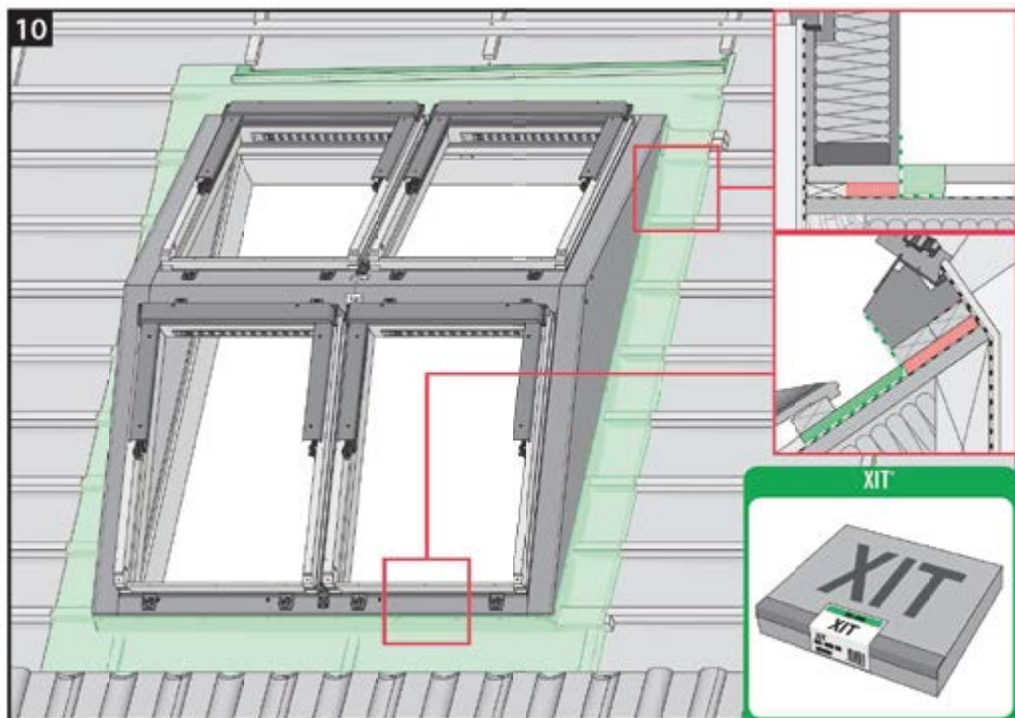
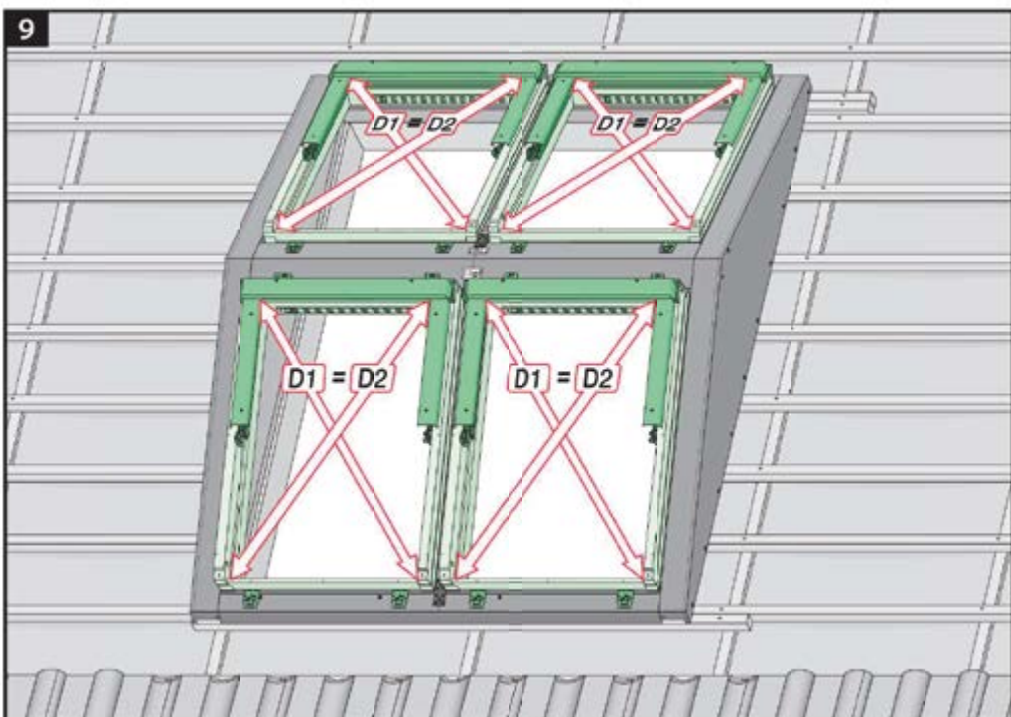

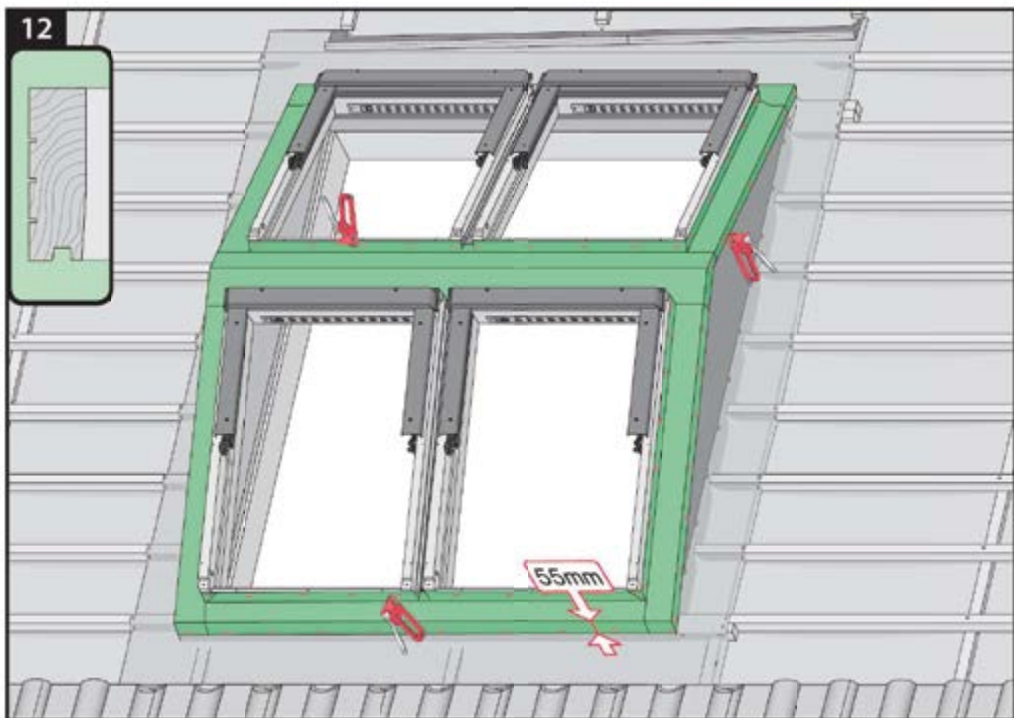
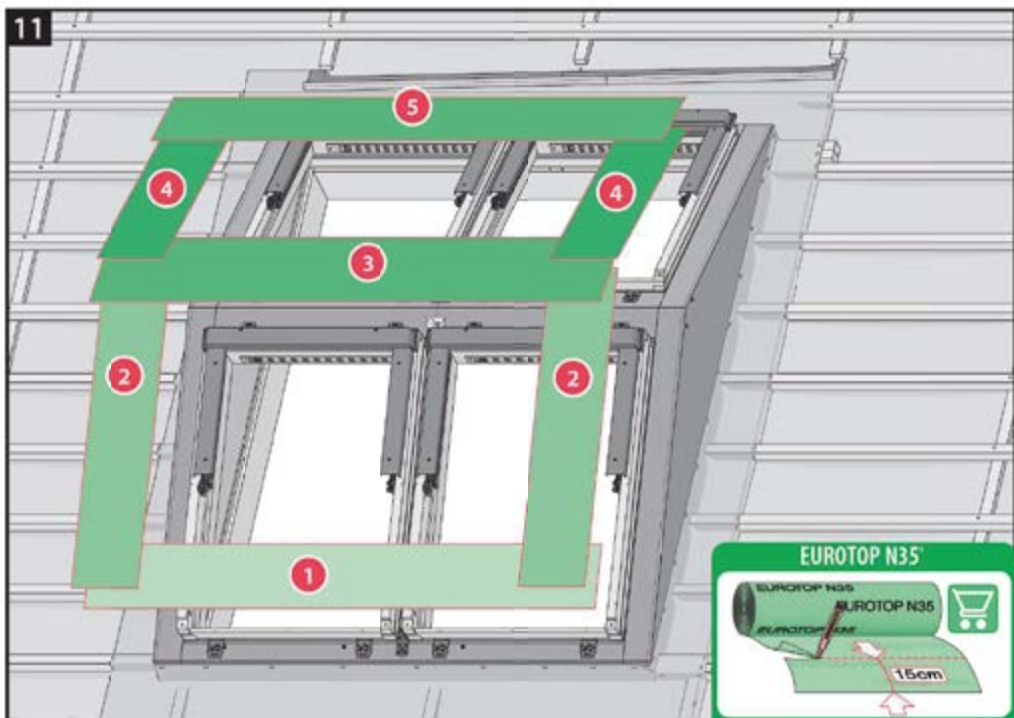

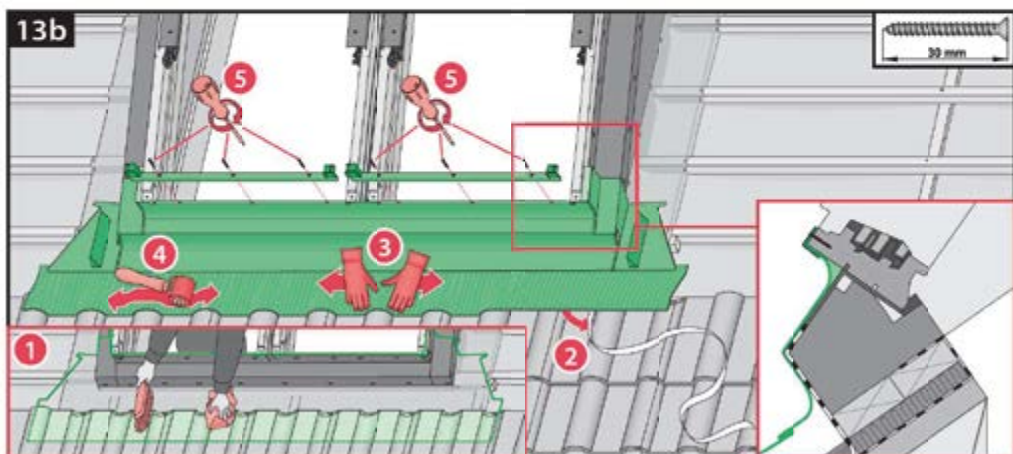
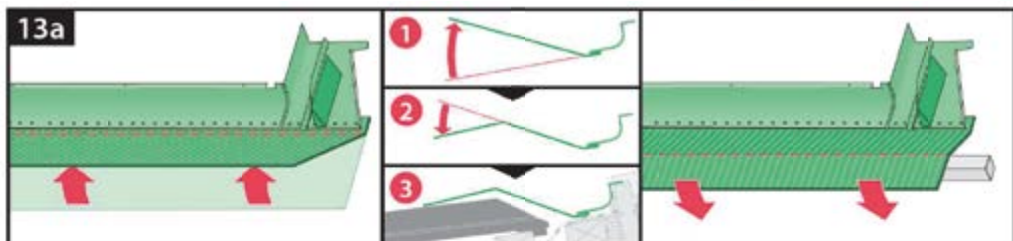
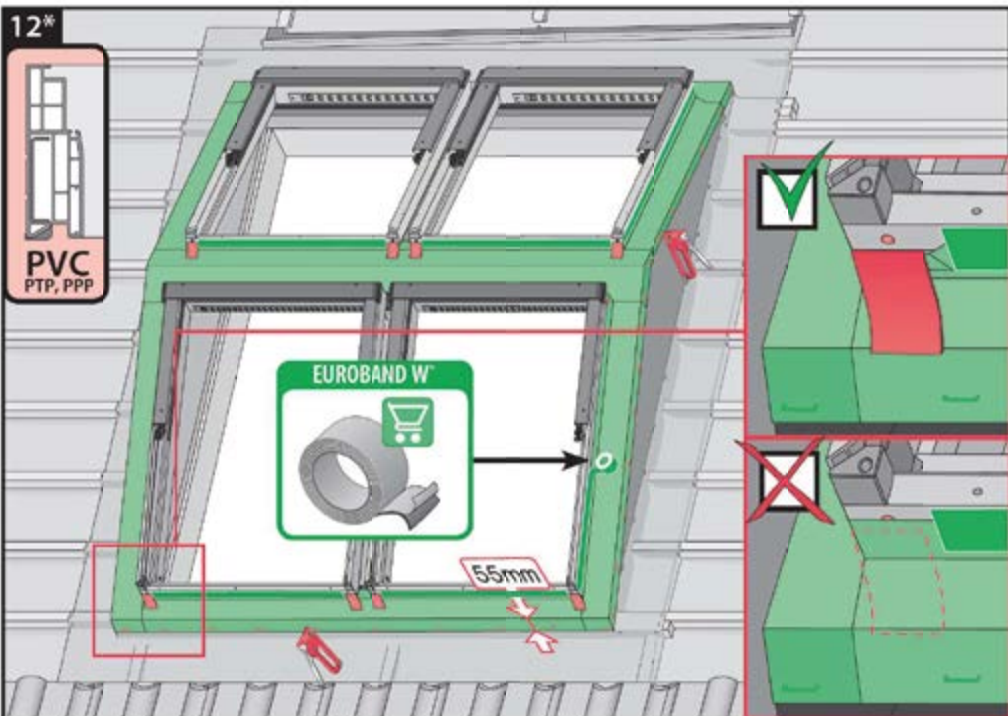

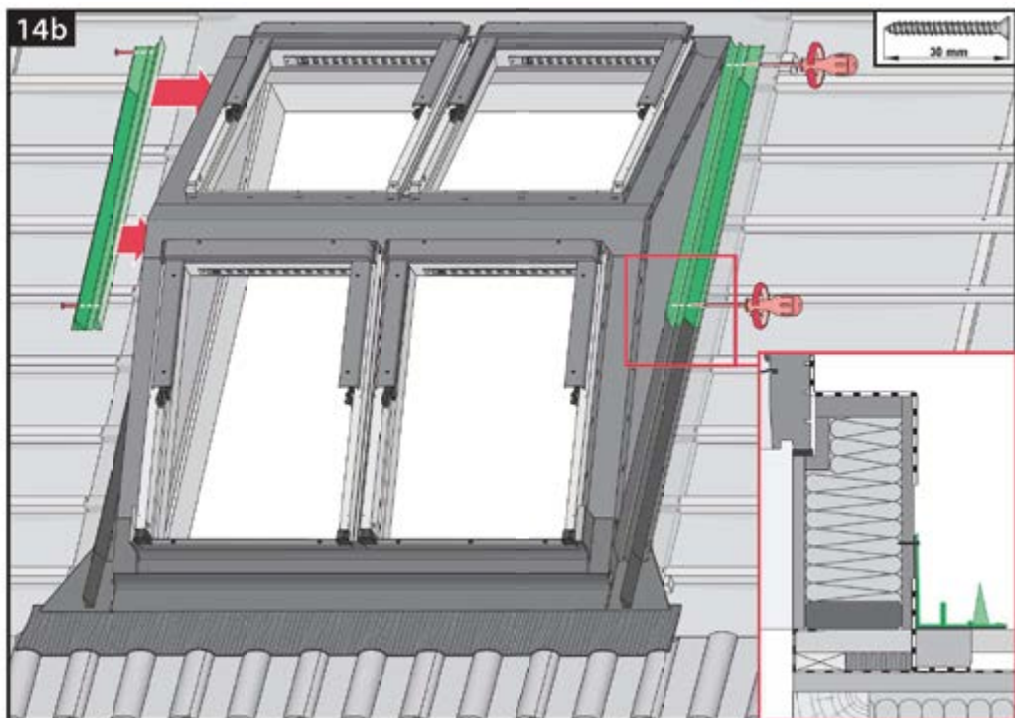
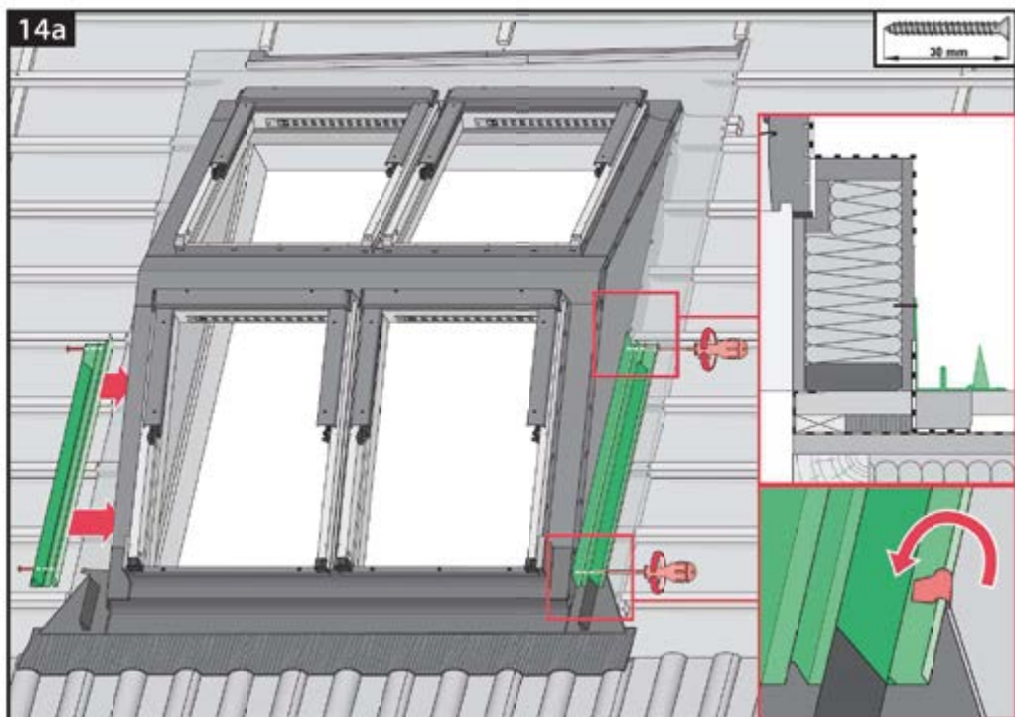

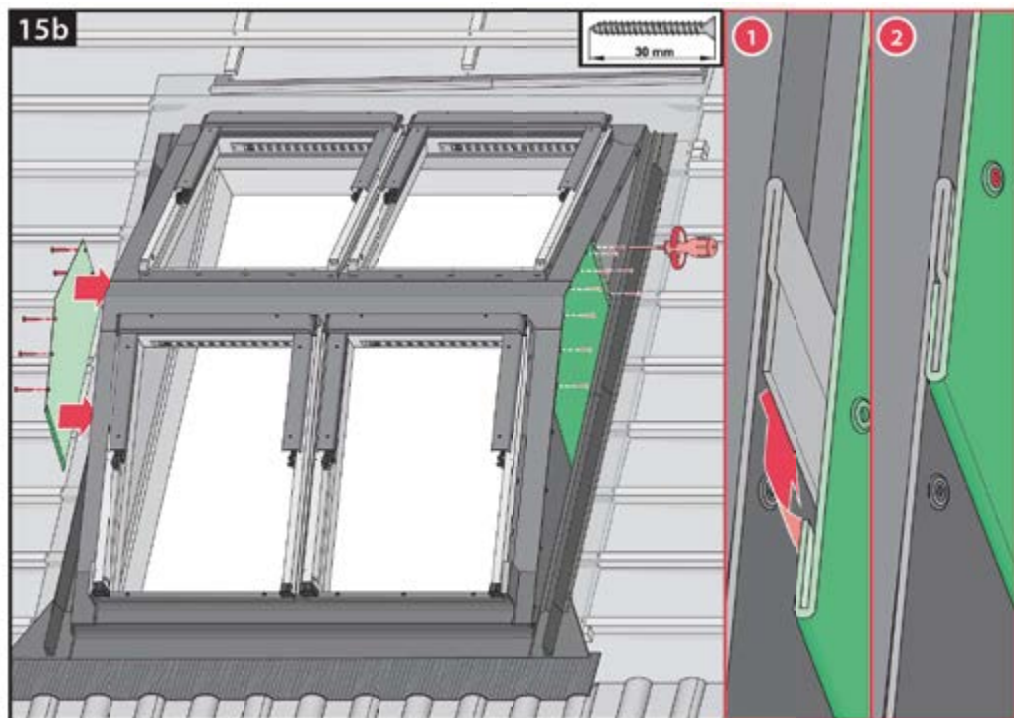
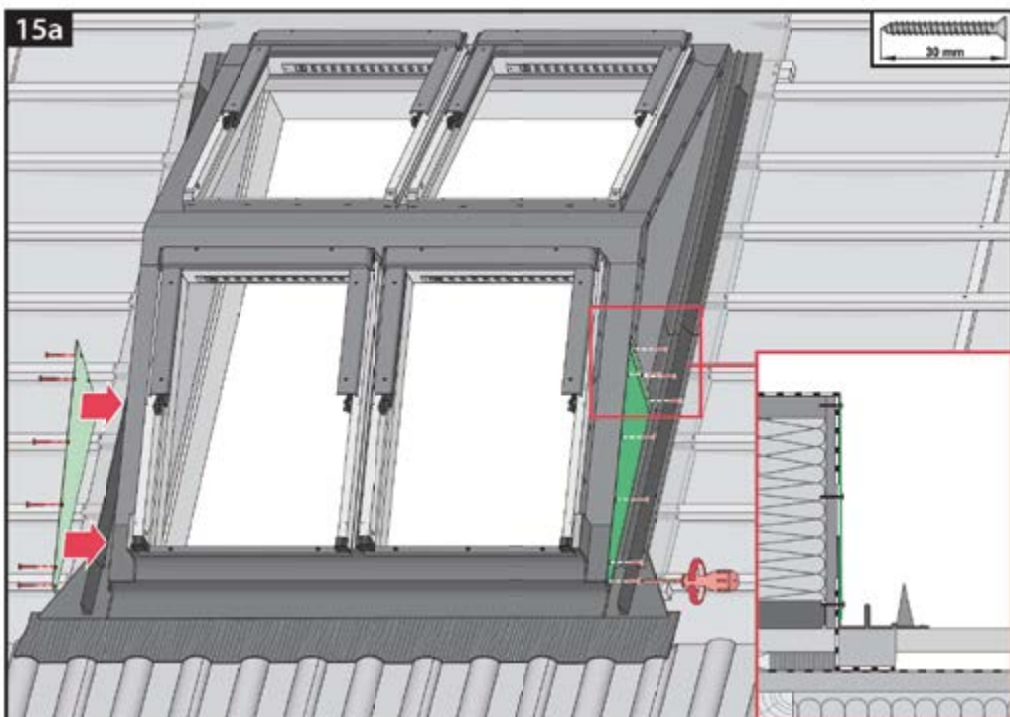

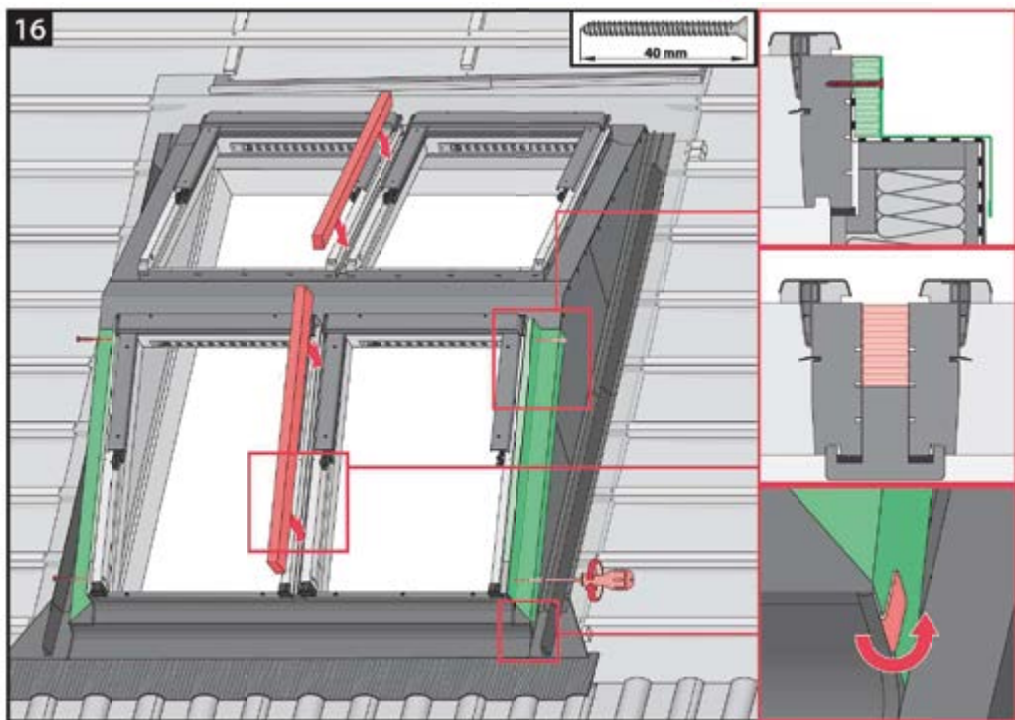
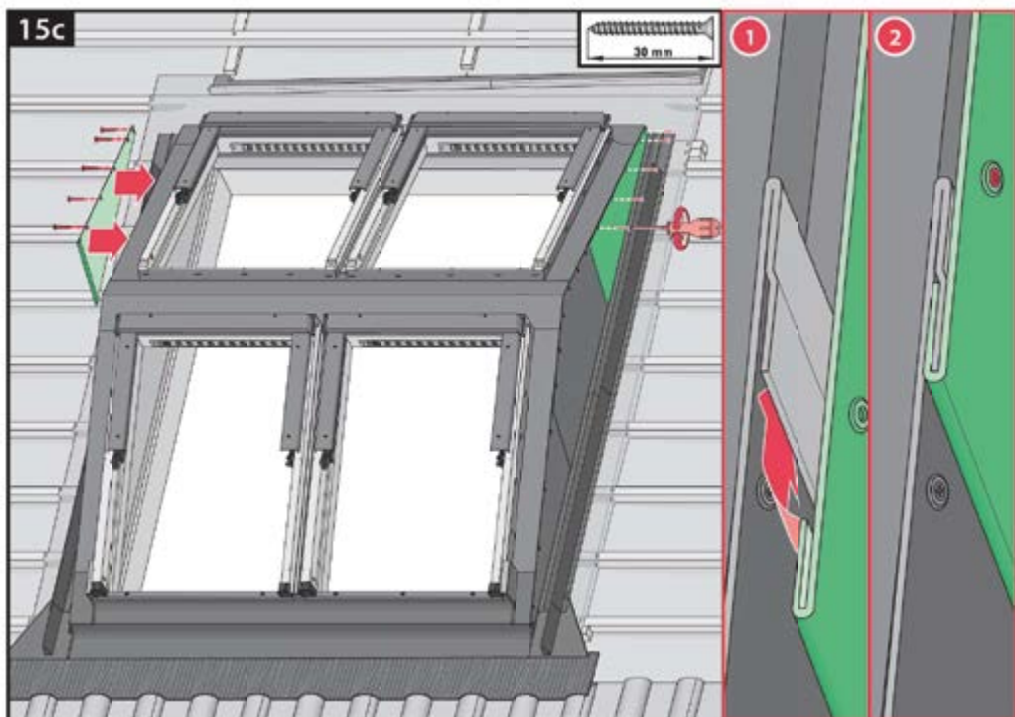

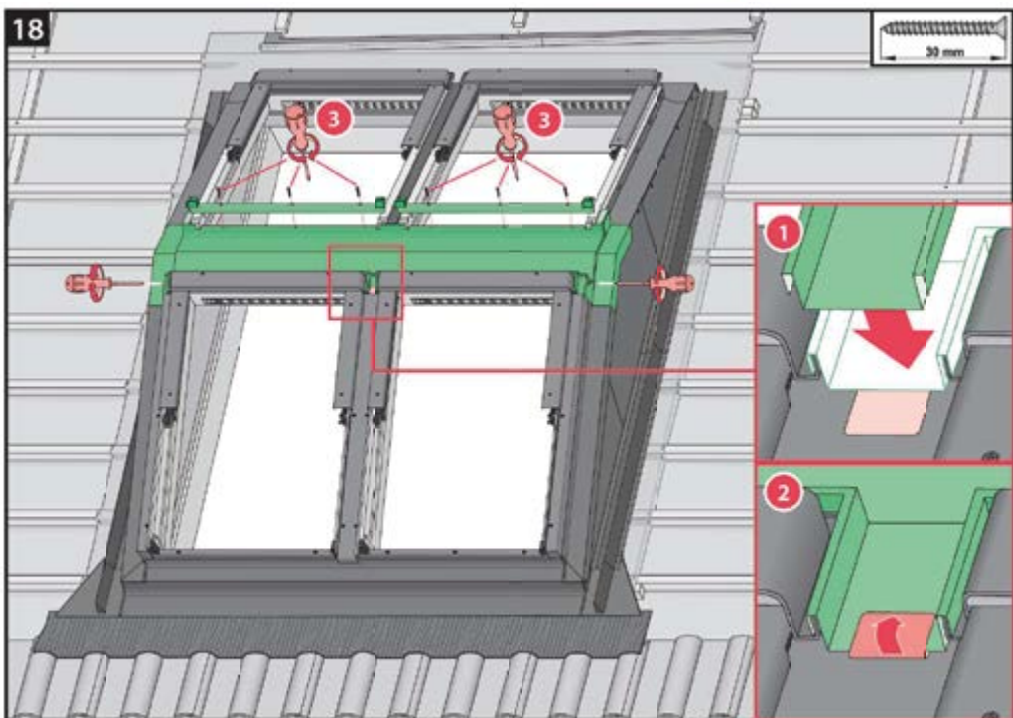
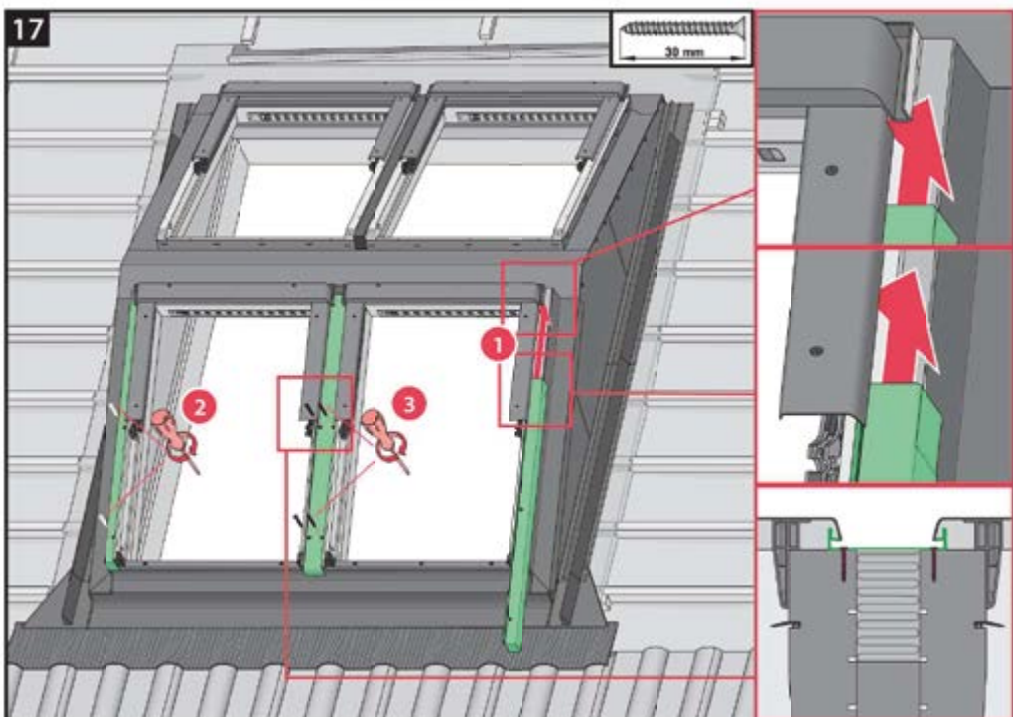

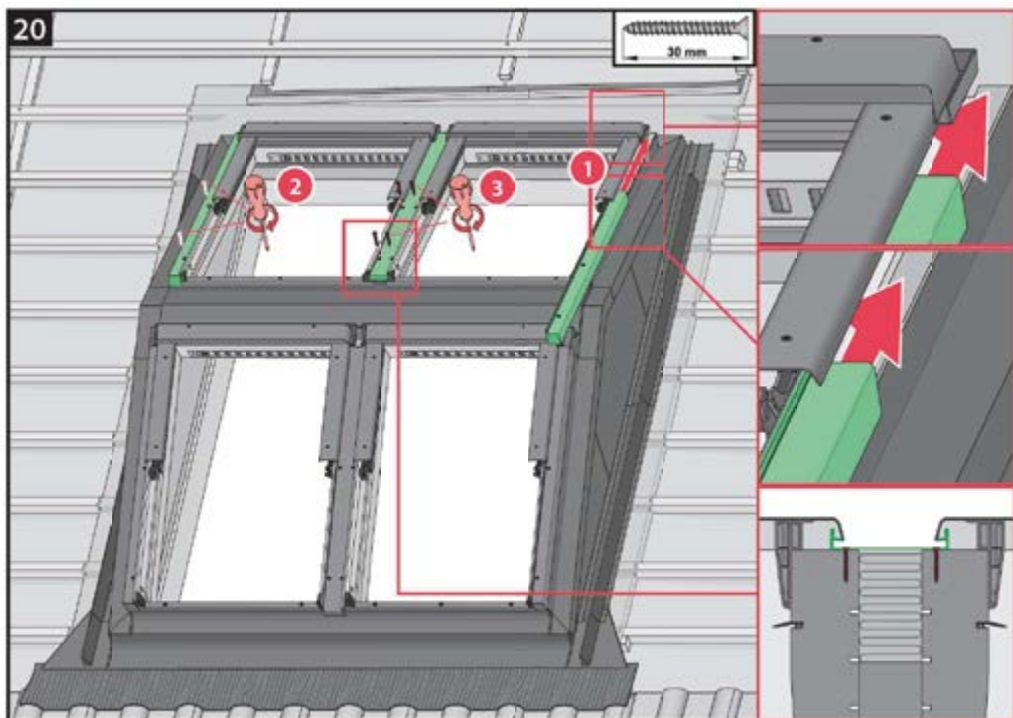
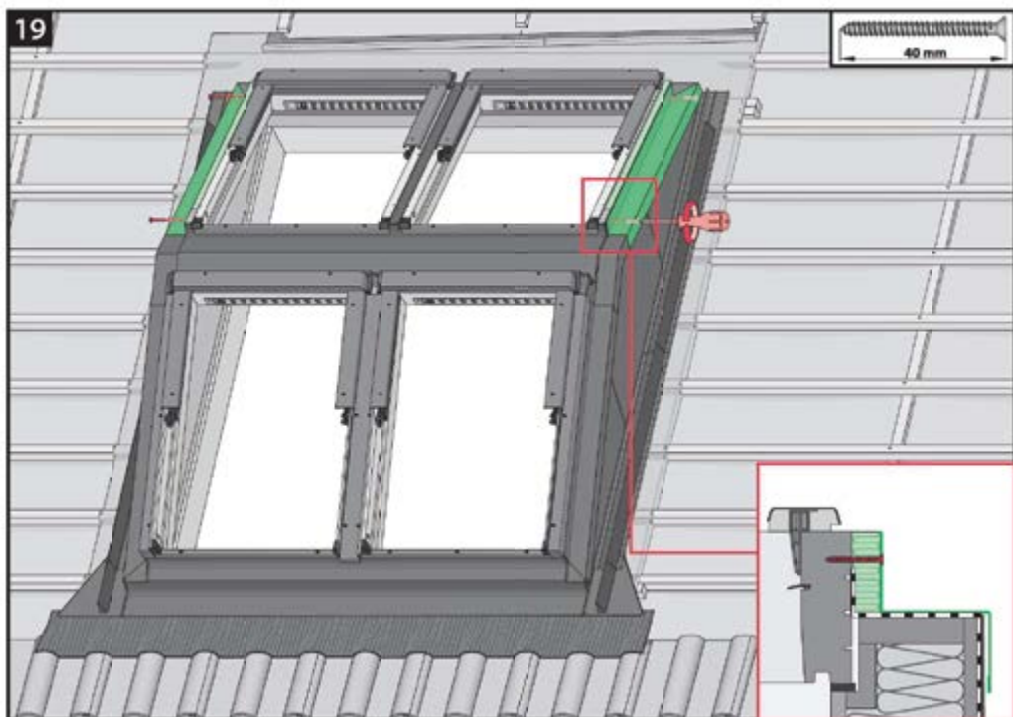

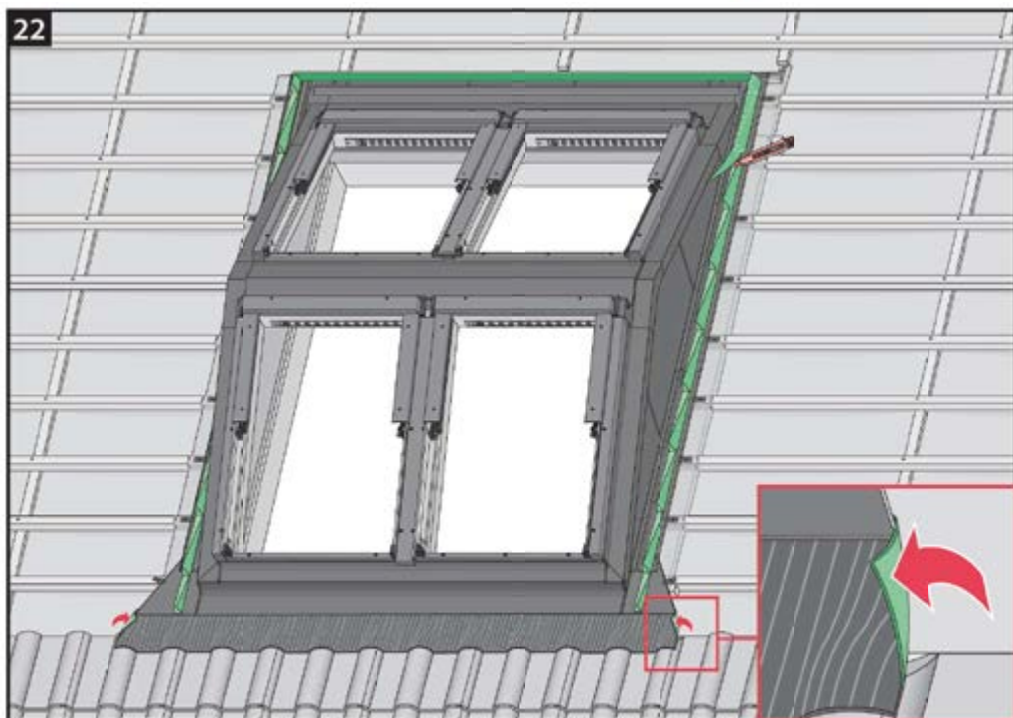
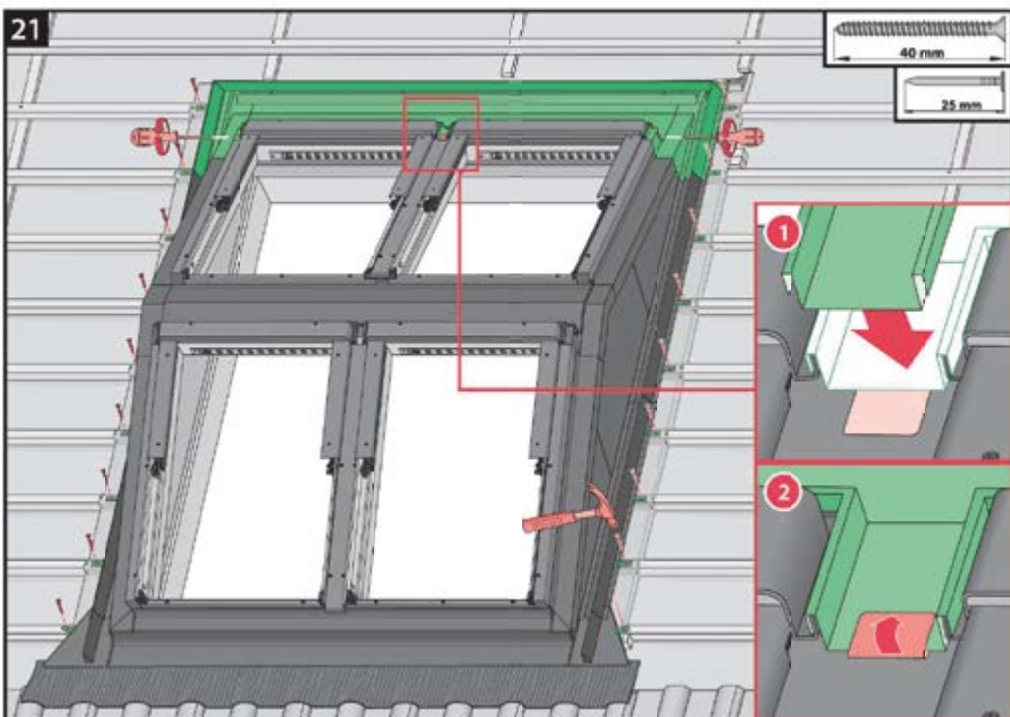

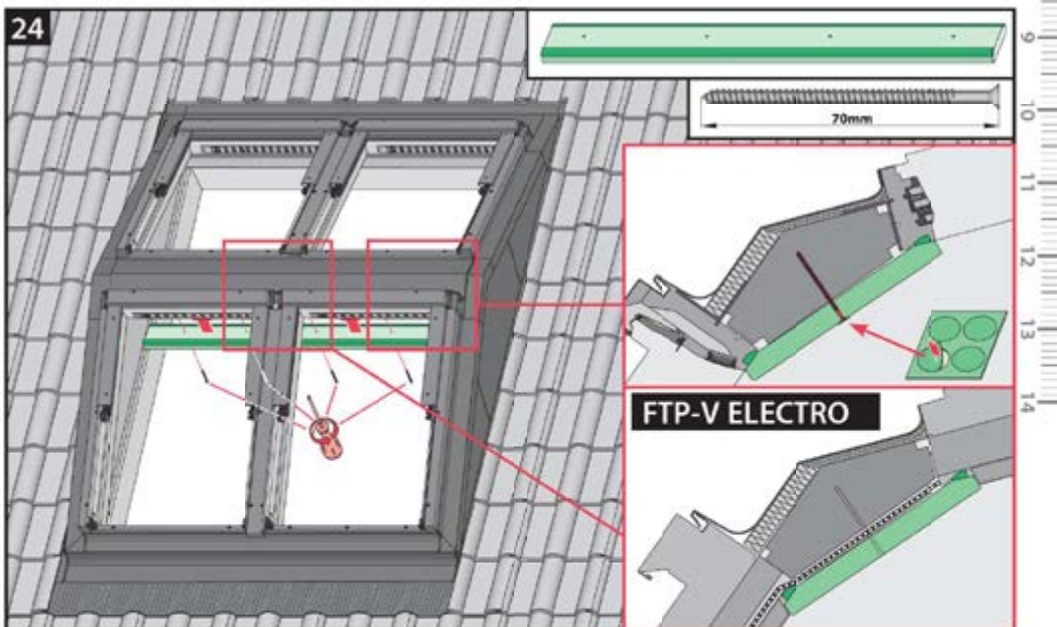
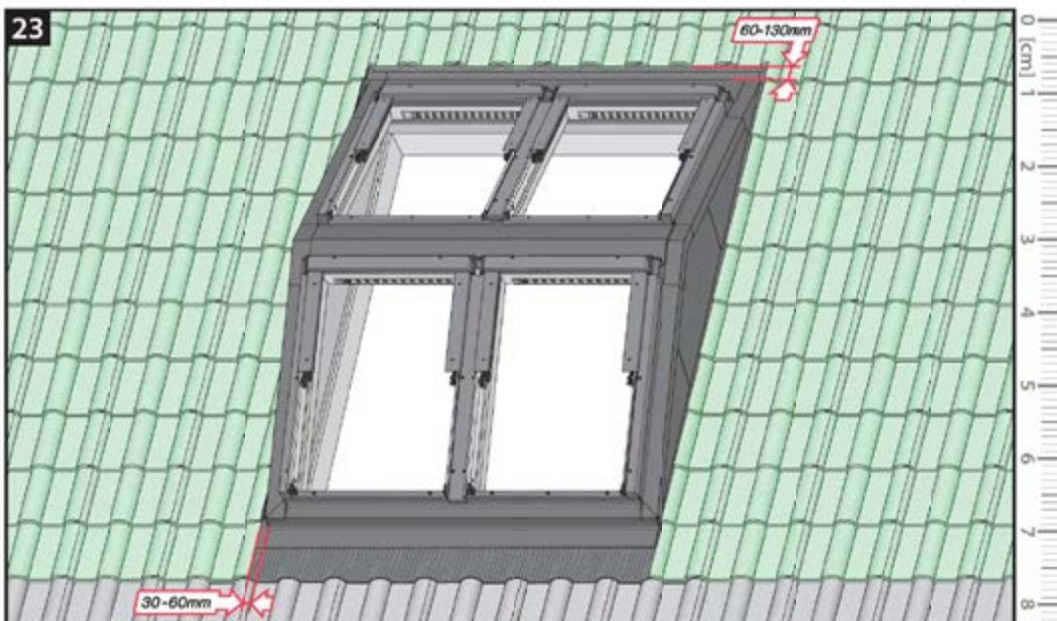

CZ Průběh při práci je třeba sledovat a instalaci přivést přesně dle, změnit přitom i bezpečnostní vzdálenosti od střešních svahů, architekton. vzhledem jako dříve uváděly.

ES El fabricante y el instalador no tienen ninguna responsabilidad por el funcionamiento de los aparatos, siempre y cuando se cumplan las exigencias de seguridad que figura en el manual de producto, instalación, mantenimiento y requisitos de edificio.

GB Manufacturer and Seller shall not be liable for failure or damage to the appliances, building works and safety requirements by the use of the product, unless they are aware of the building.

IT Il produttore e l'installatore non potranno essere ritenuti responsabili del mancato rispetto, da parte dell'utente del prodotto, del progetto, dell'installazione e del funzionamento dell'apparecchio, anche se ne vengono indicati tutti i requisiti relativi alla sicurezza.

PL Producent i sprzedawca nie ponosi odpowiedzialności za sposób funkcjonowania urządzeń, pod warunkiem, że zostały spełnione wszystkie wymagania bezpieczeństwa oraz wymagania dotyczące instalacji, montażu i eksploatacji urządzenia.

RO Nu producătorul, nu distribuitorul și nici vânzătorul nu sunt responsabili de funcționarea produselor sau de respectarea legislației de construcții sau a legislației de siguranță împotriva incendiilor pentru cauză, utilizarea, montajul sau alți defecte din partea utilizatorului.

SK Výrobca a predávateľ nie ponosi zodpovednosť za nefunkčnosť zariadení, ak boli dodržané všetky požiadavky týkajúce sa bezpečnosti pri ich používaní a údržbe, ak boli dodržané všetky požiadavky týkajúce sa požiarnej ochrany a bezpečnosti zariadení.

DE Hersteller und Händler übernehmen keine Haftung für fehlerhafte Anwendung oder für Schäden, die durch fehlerhafte Anwendung entstehen. Hersteller, Monteur oder Gebäudebesitzer.

FR Le fabricant et le vendeur ne sont aucunement responsables de ne pas respecter les lois applicables, les règlements ou les normes de sécurité de l'ouvrage de construction, d'installation, d'entretien ou de sécurité de l'ouvrage.

HU A gyártó és a forgalmazó sem vállal semmilyen felelősséget a szerelők, építők vagy felhasználók által okozott károkért.

NL De fabrikant en de importeur aanvaardt geen aansprakelijkheid voor schade van welke aard ook voortvloeiende uit het gebruik van het product.

PT O fabricante ou o vendedor não tem nenhuma responsabilidade pelo modo como o produto é utilizado, desde que se cumpram os requisitos de segurança que estão no manual de produto, instalação ou manutenção do edifício.

RU Производитель и продавец несут ответственность за исправность работы оборудования только в том случае, если соблюдены все требования безопасности и требования к условиям эксплуатации.